



**shadow**spec

umbrellas with distinction



## INTRODUCING A NEW CLASS OF SHADE

Curated shade for inspirational & dynamic spaces

## Introducing a New Class of Shade.

Shadowspec's collection of outdoor umbrellas provide class and style to outdoor settings no matter the location. With over 25 years' experience in research, development and manufacture of shade and protection products, Shadowspec has built an unparalleled product range with a reputation of real-world value - supplying world-leading designs with enduring quality.

Shadowspec outdoor umbrellas are constructed from marine-grade materials including stainless steel and single-extrusion aluminium. Our comprehensive range of stock and custom fabric colours provide exceptional UV sun protection, are water-repellant and colour-fast. Our elegant, effortless shade systems are here to help you sculpt your outdoor space into an iconic, warm and welcoming space.

### SHADOWSPEC UNITY™

page 4



Engineered and hand-built at the Heron Base, the Shadowspec Unity™ is our new flagship premium outdoor umbrella. We've created an umbrella that stands up to everyday use whilst being easy to use and quick to deploy.

### SHADOWSPEC SERENITY™

page 10



Rotate your way to perfect shade with the exceptional design of the Shadowspec Serenity™. Our smart umbrella is designed to be adjustable and enduring. Lighten the load with Shadowlift technology and a built-in LED light.

### SU2

page 17



The hunt for shade at your cafe/restaurant, resort or home needn't travel any further. The SU2 Cafe & Resort Umbrella is here to provide your space with a steady, curated shade.

### SU3

page 23



The SU3 Wall Mounted Umbrella is designed for small and unique residential spaces and can be mounted on posts, pillars, walls and beams giving you the flexibility to sculpt the shade to suit your home.

### SU4

page 28



Our easy-to-use tilting SU4 umbrella, designed to move shade with you. Offset your shade to create a social environment in any of your outdoor spaces.

### SU10

page 34



The SU10 is engineered to work hard in a range of applications, al fresco dining, poolside at the resort or as a patio umbrella outside the cafe. The size, strength and clever design set the SU10 apart.





## SHADOWSPEC UNITY™

### The Evolution of Shade. Innovative, modular and exclusive.

The Shadowspec Unity™ has been crafted with premium-grade aluminium and stainless steel to provide you with an umbrella that stands up and stands out.

Every component is designed and engineered to survive in the wild. Taking inspiration from nature, this flagship model is easy to open and looks stunning in any outdoor setting. It's an outdoor shade solution perfect for hospitality or home.

The Shadowspec Unity™ sits squarely (or octagonally) in a class of its own. You'll find no antiquated crank handles, cables or internal moving parts that create a laborious process and are prone to breakage.

You'll continue to be inspired by this brilliant, modern and modular outdoor shade umbrella. The needle-shifting features get better with every open and every new discovery of innovation you make.





**PATENT-PENDING TECHNOLOGY**

**SHADOWLIFT™**



Gas-assisted deployment for an easy lift.

**SHADOWGLIDE™**



Engineered to open or close in 5 seconds.

**SHADOWHUB™**



LED light technology built-in and App controlled.

**SHADOWLOCK™**



Integrated security and wind-protection.



Featuring Marine-Grade 316 Stainless Steel Spigot.

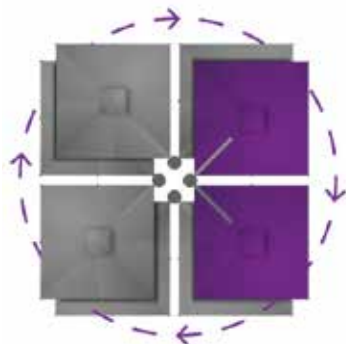

Rotates 360° (Ground Mounted).

**Size & Configuration**

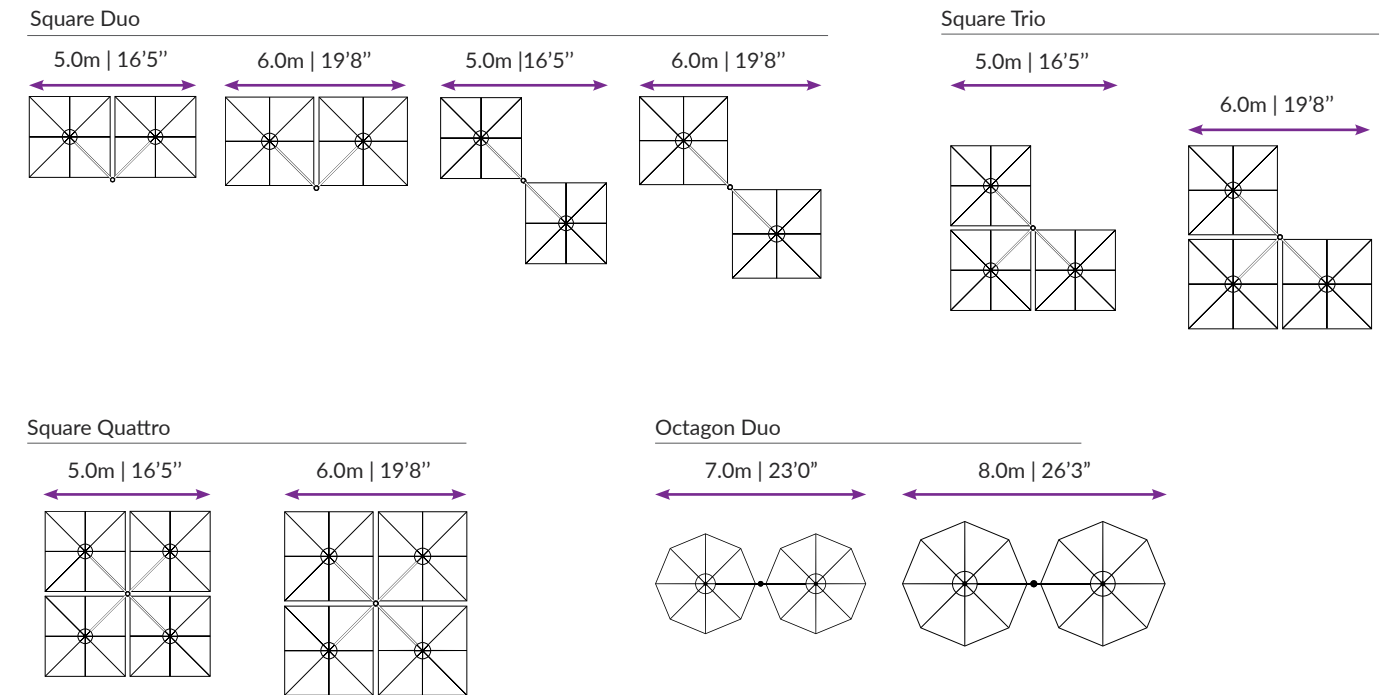

**Canopy**

**Features**

- 100% Marine-grade solution-dyed acrylic fabric
- All fabrics can be cleaned, washed and are replaceable
- UV & fade resistant
- 10 year Sunbrella™ and Recasens warranties
- Mould and mildew resistant
- Weight: 314 g/m2
- Sun protection - Skin Cancer Foundation's seal of approval

Full Sunbrella range also available as a custom colour option.\*Non-stock & custom colours will incur an additional lead time and surcharge.

**RECASENS**  
BCN 1886

**Stock Colours**

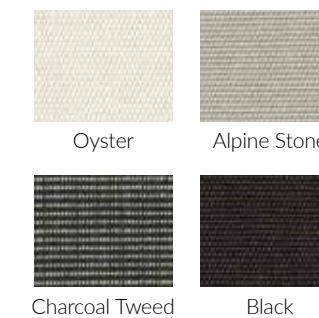

**sunbrella®**

**Non-Stock Colours\***



**BEST-IN-CLASS WARRANTY**

Relax easy knowing your outdoor umbrella purchase is protected by the industry's best warranty (conditions apply) and customer support. 3 year warranty applies for commercial applications.



**Fabric Warranty**



**Frame Warranty**









## SHADOWSPEC SERENITY™

### Precision Engineered Ambience Effortless Protection for Prestigious Spaces.

The Shadowspec Serenity™ has been designed with careful consideration and consistency. The technology we've developed works in perfect harmony to give you the most advanced umbrella deployment system in the industry.

We're committed to evolving and innovating and our patent-pending technology is a prime example of that, giving you the ability to open or close the Serenity™ in just 5 seconds. The umbrella has been designed to be ready to go right out of the box; install it anywhere in your outdoor space and get the instant benefit of a rotatable shade solution.





**PATENT-PENDING TECHNOLOGY**

**SHADOWLIFT™**



Gas-assisted deployment for an easy lift.

**SHADOWGLIDE™**



Engineered to open or close in 5 seconds.

**SHADOWHUB™**



LED light technology built-in and App controlled.

**SHADOWLOCK™**



Integrated security and wind-protection.



Featuring Marine-Grade 316 Stainless Steel Spigot.

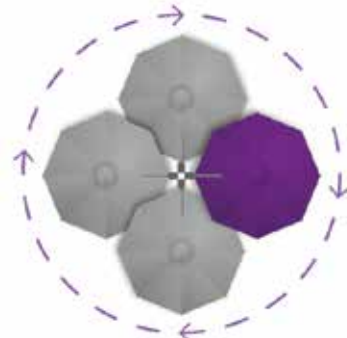

Rotates 360° (Ground Mounted).

**Size & Configuration**

Square

2.5m | 8'2"

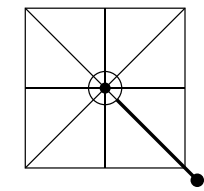

3.0m | 9'10"

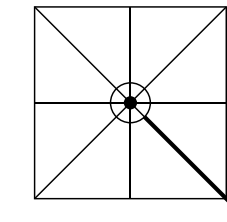

Octagon

3.5m | 11'6"

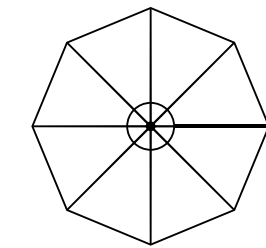

4.0m | 13'2"

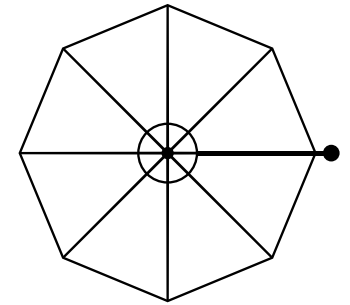

**Canopy**

Features

- 100% Marine-grade solution-dyed acrylic fabric
- All fabrics can be cleaned, washed and are replaceable
- UV & fade resistant
- 10 year Sunbrella™ and Recasens warranties
- Mould and mildew resistant
- Weight: 314 g/m2
- Sun protection - Skin Cancer Foundation's seal of approval

Full Sunbrella range also available as a custom colour option.\*Non-stock & custom colours will incur an additional lead time and surcharge.

**RECASENS**  
BCN 1886

**sunbrella®**

Stock Colours

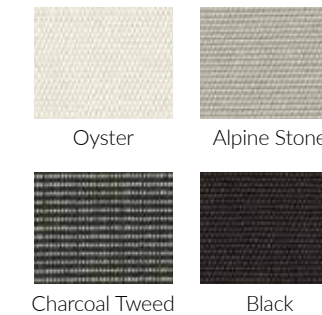

Non-Stock Colours\*

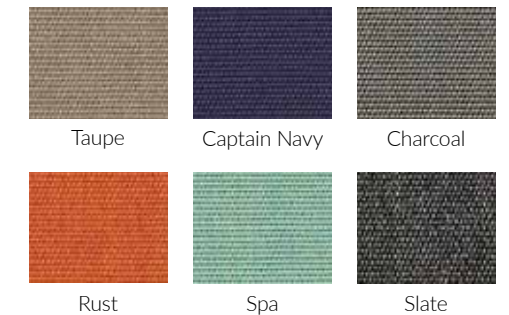

**BEST-IN-CLASS WARRANTY**

Relax easy knowing your outdoor umbrella purchase is protected by the industry's best warranty (conditions apply) and customer support. 3 year warranty applies for commercial applications.



**Fabric Warranty**



**Frame Warranty**

SHADOWSPEC SERENITY™







## SU2

### CAFE AND RESORT UMBRELLA

**Stylish, resilient and individual.  
Ideal hospitality shade.**

Meet our take on the classic market umbrella, the SU2 is easy to use, stable and enduring. The perfect umbrella for home & hospitality settings, offer your guests premium protection from the sun and rain whilst adding a certain style, class and functionality to your outdoor space.

The SU2 Cafe & Resort Umbrella is available in a variety of canopy shapes, sizes and colours, with both Surface Plate and Portable Base fixing options.

The SU2 is a popular hospitality product and we often supply custom branding, colours and designs to help your establishment expand their footprint out in front of the public.

Add a splash of style to your setting with a hospitality-level Cafe & Resort Umbrella.





Features at a glance

- Simple and easy to open and close
- Heavy-duty double pulley system
- Commercial grade pulley rope
- Glass-filled nylon high-performance hubs and brackets
- Marine grade anodised aluminium frame and pole
- Stainless steel fastenings and components
- Commercial strength pole with a large diameter and thick aluminium wall.



Strut Arms

All Shadowspec SU2 Umbrellas have eight full strength 20mm x 33mm strut arms.

Size & Configuration

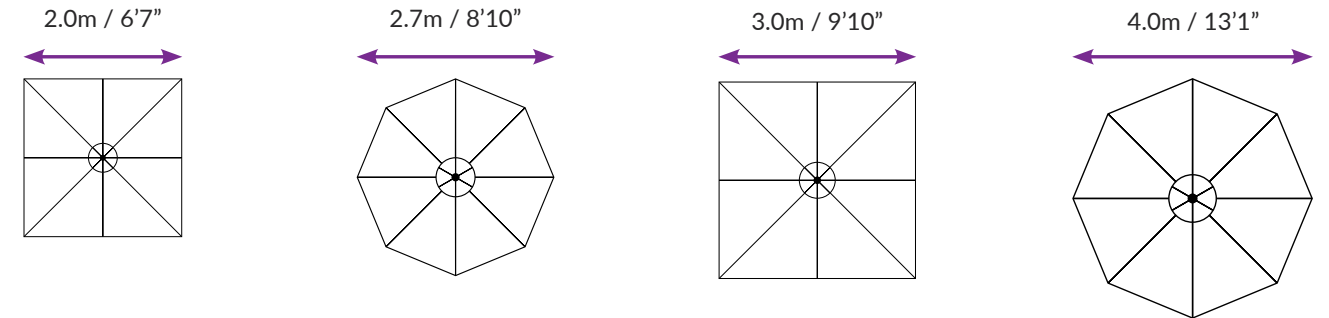

Canopy

- Premium 100% solution dyed canopy
- Maintenance: All fabrics can be washed and are replaceable
- Shade Rating: UPF 50+

Colours\*



\*other custom colours available on request.

Custom Branding



We specialise in custom branding umbrellas with your logo/brand and message.

BEST-IN-CLASS WARRANTY

Relax easy knowing your outdoor umbrella purchase is protected by the industry's best warranty and customer support.



Fabric Warranty



Frame Warranty



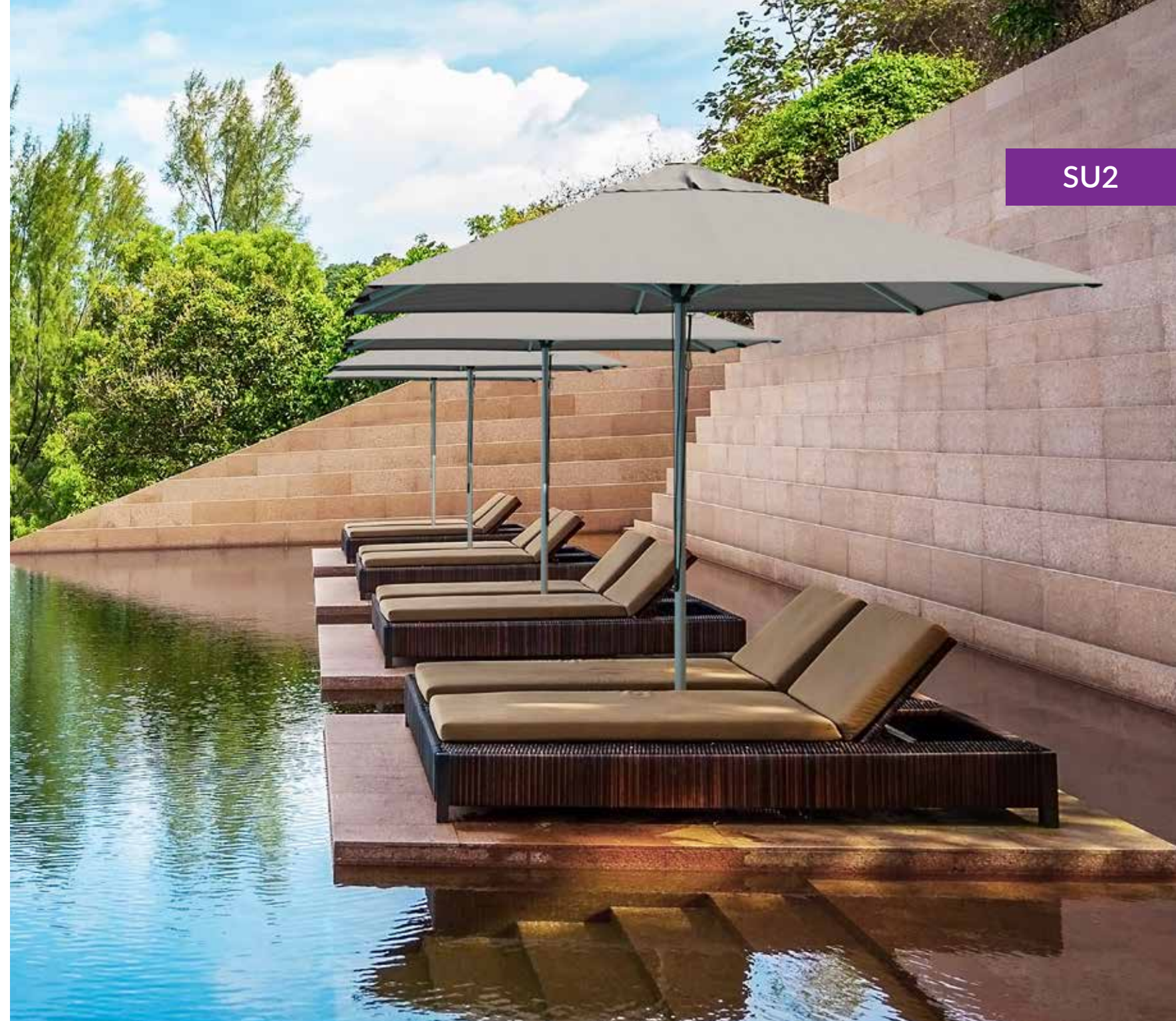





## SU3 WALL MOUNTED UMBRELLA

### **Adaptable, modest, and convenient. Versatile shade for unique spaces.**

The SU3 Wall Mounted Umbrella is designed for small and unique spaces and can be mounted on posts, pillars, walls and beams giving you the flexibility to sculpt the shade to suit your needs.

This wall mounted sun umbrella is ideal for shading your spa pool from the sun as the canopy has UPF 50+ which blocks 98 percent of the sun's rays.

Cover your patio, balcony, deck or courtyard. The SU3 wall umbrella can be folded down, covered or put away for storage when it's not required. If you've got an outdoor nook that needs shade to finish it off, then the SU3 wall mounted outdoor umbrella is here to create a unique outdoor experience for you and your guests.





Size & Configuration

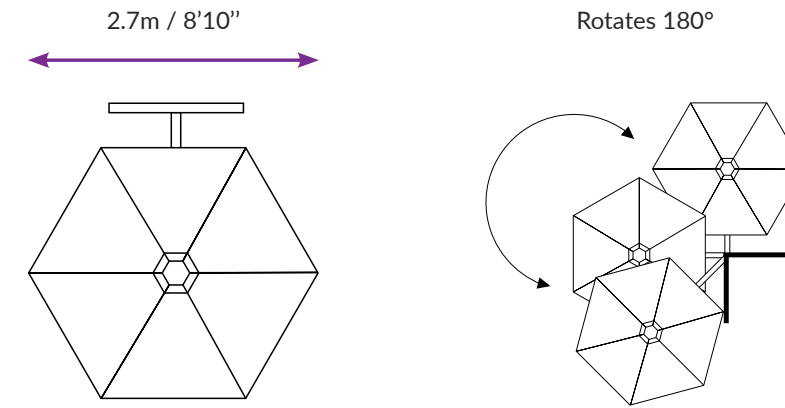

Features at a glance

- Manufactured from top quality anodised aluminium, stainless steel and other non-corrosive materials
- Telescopic arm - 1400mm / 4'7" out to 1800mm / 5'11"
- Umbrella can swing horizontally
- Umbrella can tilt 18°

Canopy

- Premium Olefin 'COSLAN' - 100%
- Maintenance: All fabrics can be washed and are replaceable
- Shade Rating: UPF 40+
- Colourfastness: 6-7/8
- Weight: 190 g/m2

Colours\*



Telescopic Arm Adjustment

400mm / 1'4"



Tilting

Tilts 18°

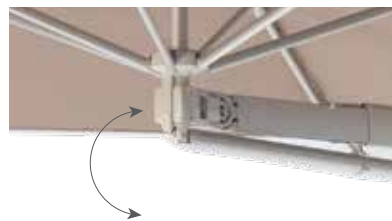

Wall Bracket

One included as standard.



**BEST-IN-CLASS WARRANTY**

Relax easy knowing your outdoor umbrella purchase is protected by the industry's best warranty and customer support.



Fabric Warranty



Frame Warranty



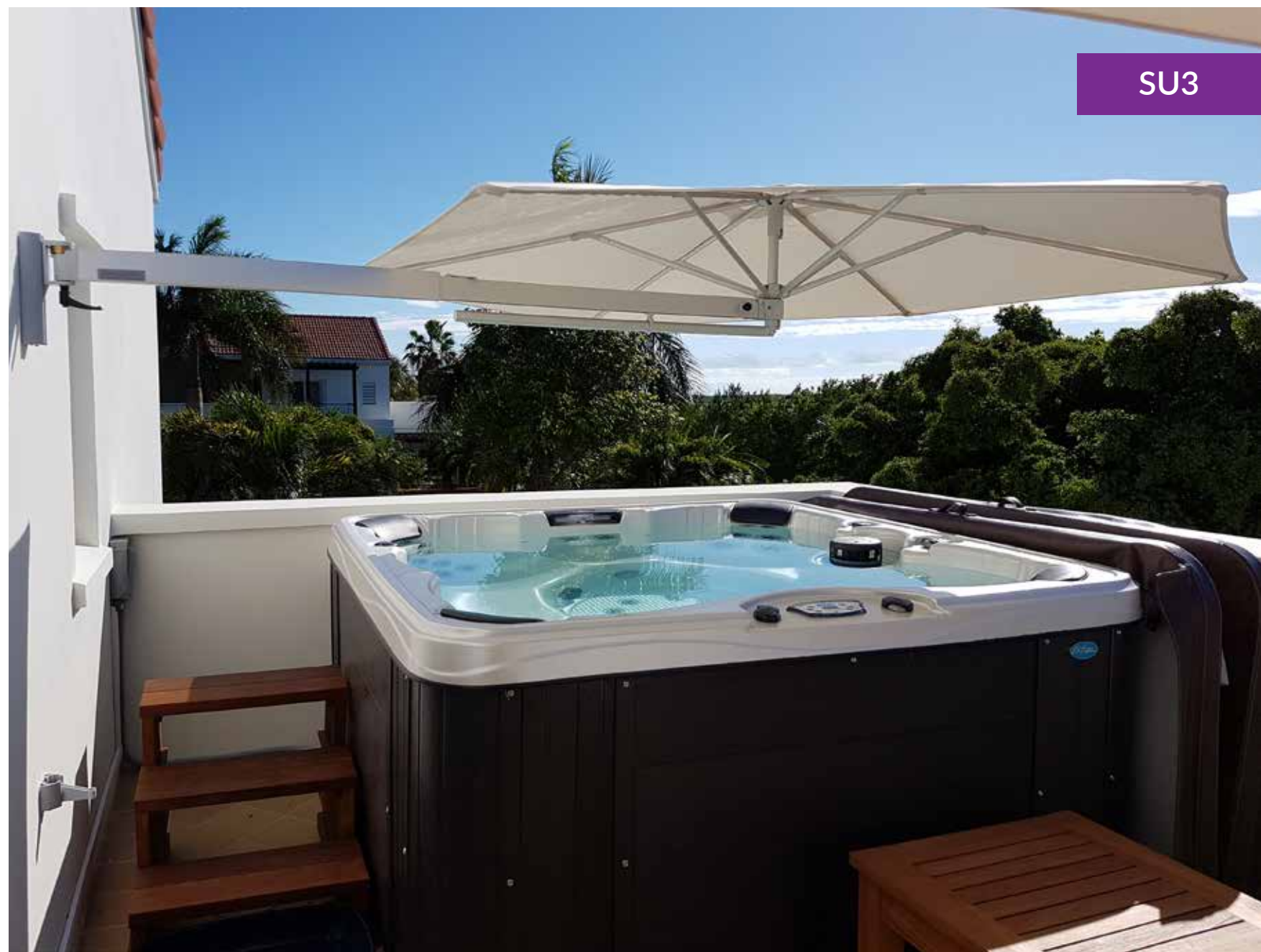
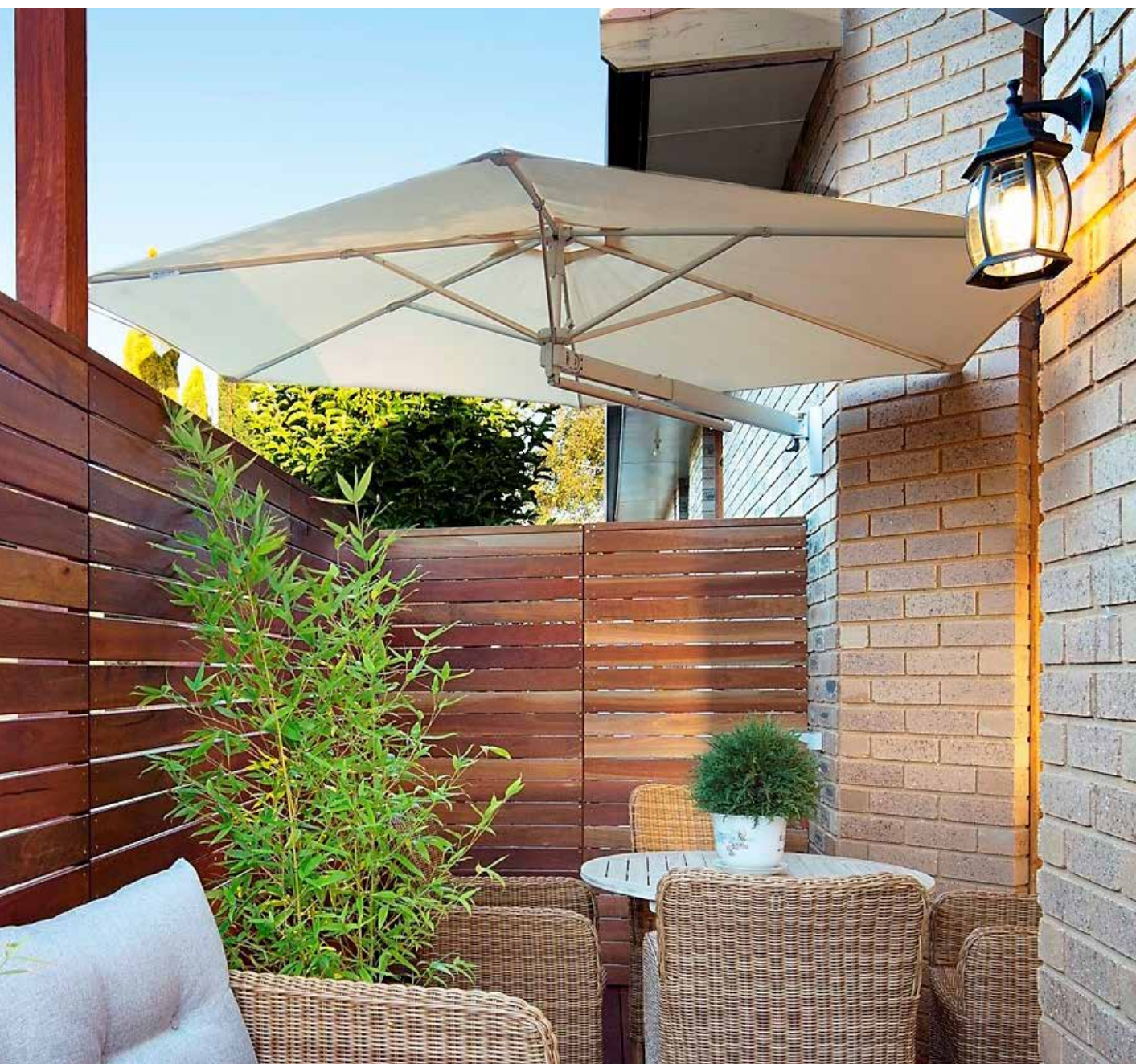
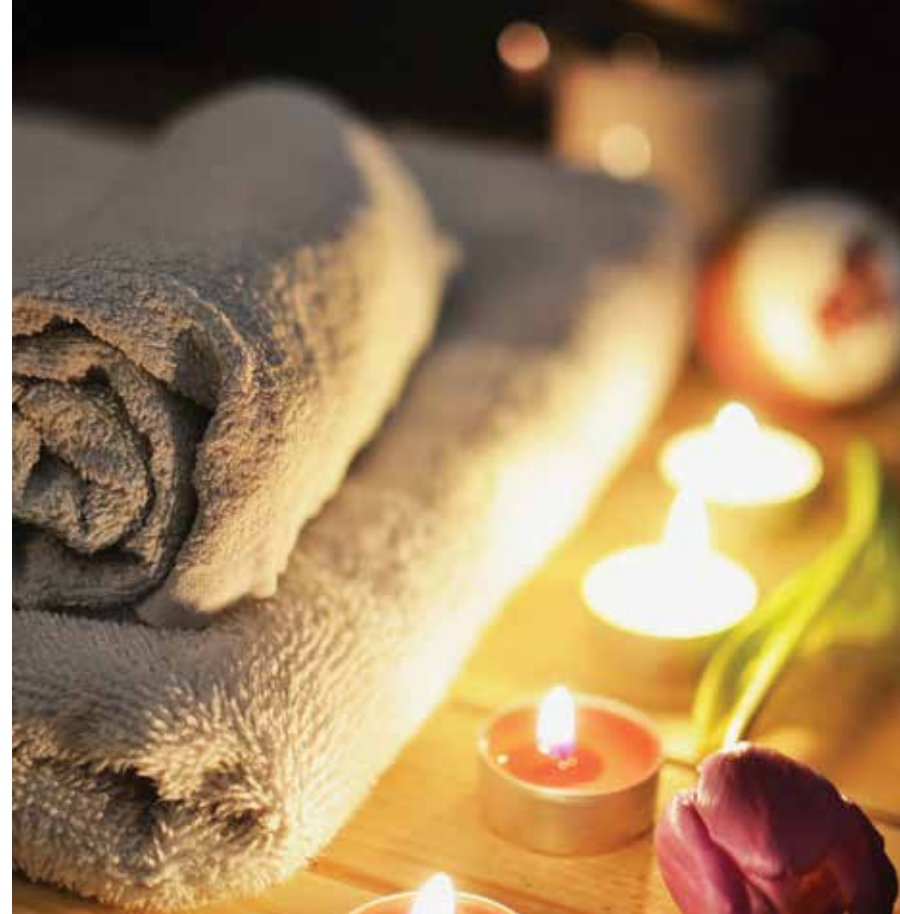





## SU4

### TILTING OFFSET UMBRELLA

**Refined, functional and adaptable.  
Simple shade with clever capabilities**

The SU4 is our easy-to-use tilting umbrella, designed to move shade with you. Offset your shade to create a social environment in your outdoor spaces, open-up the conversation with clear sight-lines for an intimate and practical experience.

The standout feature of the SU4 Umbrella is the ability to not only rotate 360 degrees but it can also tilt to almost vertical making it the ideal tilting sun umbrella.

Engineered to provide effortless shelter for all environments, the SU4 is the perfect tilting patio umbrella for your home or tilting sun umbrella for your café or restaurant. The cantilever design enables you to get the most out of your space.

Unlock the potential of your space with the Su4 patio umbrella tilt mechanism that's built to last and built to perform.



Size & Configuration

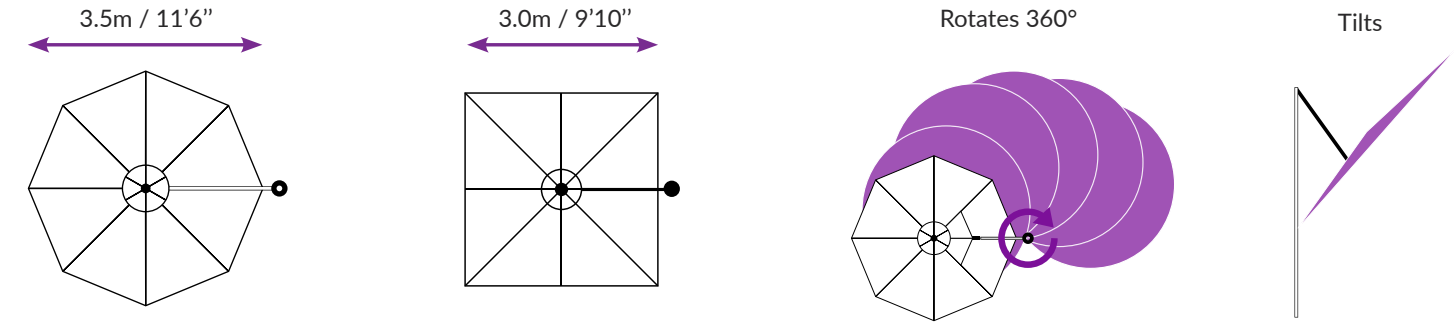

Canopy

- Commercial Grade: 100% solution dyed
- Maintenance: All fabrics can be washed and are replaceable
- Shade Rating: UPF 50+
- Colourfastness: 4/5
- Weight: 290 g/m2
- Waterproof Rating: >300mm water column

Features at a glance

- Tilts
- Marine grade aluminium frame and stainless steel hardware for longevity
- Elegant and simple to operate tilt system
- Rotates 360°
- Durable high performance hub and fittings
- Custom designed protective cover included



Colours\*



\*other custom colours available on request.

BEST-IN-CLASS WARRANTY

Relax easy knowing your outdoor umbrella purchase is protected by the industry's best warranty and customer support.



Fabric Warranty



Frame Warranty









## SU10

### COMMERCIAL CENTRE POLE UMBRELLA

**Tough, generous, and practical.  
Heavy-duty protection for enduring spaces.**

Designed to cover a wide range of applications and spaces. The heavy-duty SU10 Commercial Umbrella is engineered for hospitality proprietors to get the most out of their outdoor and alfresco spaces. Large outdoor umbrellas lower the setup time for staff and cover a substantial seating space, with just one product.

The true power of the SU10 is the telescopic mast design. This feature allows the SU10 to close above the standard height of the furniture. This large umbrella is available in multiple sizes, colours and configurations, with Surface Plate, In-ground Anchor or Portable Base mounting options.





Size & Configuration

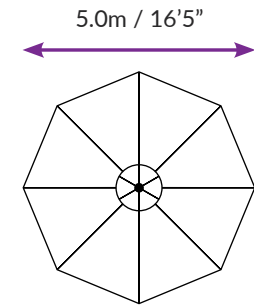
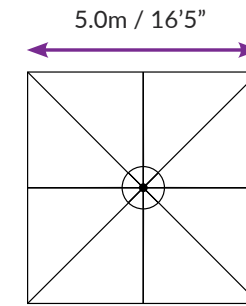
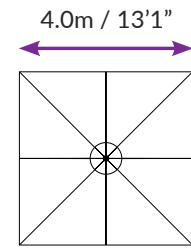

Canopy

- Premium Sunbrella Acrylic - 100% Solution Dyed
- Waterproof Rating: >300mm water column
- Maintenance: All fabrics can be washed and replaced
- Weight: 315 g/m2
- Colourfastness: 7-8/8
- Shade Rating: UPF 50+



Features at a glance

- Commercial grade aluminium frame structure
- Stainless steel hardware for longevity
- Durable high performance hub and fittings
- Telescopic mast enables umbrella to clear most furniture when closing
- Robust 82.5mm / IMM mast with 3.4mm wall thickness
- Custom designed protection cover included
- Tough, commercial grade 50 x 25mm strut arm profile

Colours

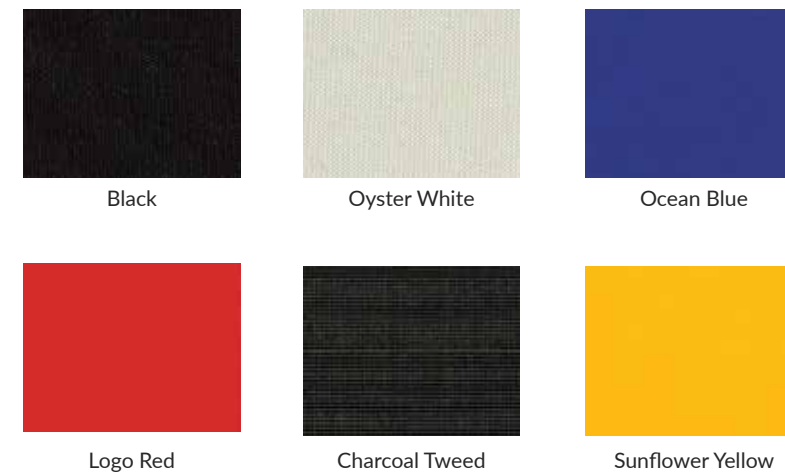

Custom Branding



We specialise in custom branding umbrellas with your logo/brand and message.

Accessories



Rain Gutter

Adjoining square umbrellas can be connected with removable rain gutters to increase weatherproof area.

\*other custom colours available on request.

BEST-IN-CLASS WARRANTY

Relax easy knowing your outdoor umbrella purchase is protected by the industry's best warranty (conditions apply) and customer support. 3 year warranty applies for commercial applications.



Fabric Warranty



Frame Warranty



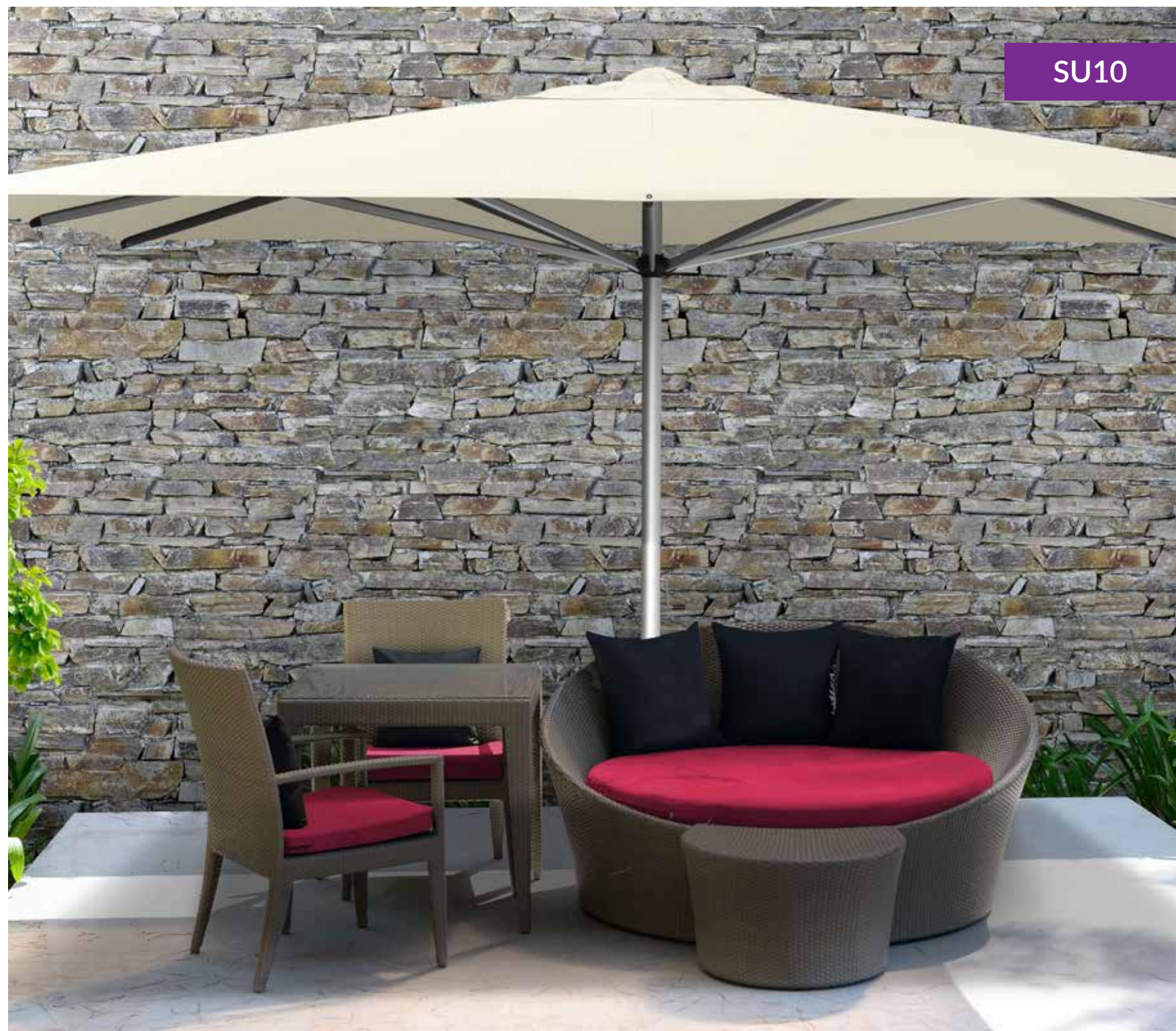



# UMBRELLA FIXINGS

## Mounting options for any spaces

Style and finish may vary across models

### UNITY™ | SERENITY™ | SU4 | SU10

#### Surface Plate

For deck, patio and concrete mounting.



#### In-Ground Anchor

For mounting with a concrete footing.



#### Free-Standing Base + Aluminum Base Cover\*

For complete customized maneuverability.



\*Concrete Pavers are required for ballast (not supplied).  
Castor Wheels optional.

### UNITY™ | SERENITY™

#### Wall Base Bracket

For when ground mounting isn't possible.



### SU2

#### Surface Plate

#### Steel Flat Plate Base

#### Concrete Base



### SU3

#### Wall Bracket



**shadow**spec  
umbrellas with distinction